



Einfach. Sicher.



DECLARATION OF PERFORMANCE

DoP: 0062

for Upat Drop-in Anchor USA (Metal anchors for use in concrete (heavy-duty type)) – EN

1. Unique identification code of the product-type: **DoP: 0062**
2. Intended use/es: **Post-installed fastening in uncracked concrete, see appendix, especially Annexes B 1 to B 4**
3. Manufacturer: **Upat Vertriebs GmbH, Bebelstraße 11, 79108 Freiburg im Breisgau, Germany**
4. Authorised representative: --
5. System/s of AVCP: **1**
6. European Assessment Document: **EAD 330232-00-0601**  
European Technical Assessment: **ETA-10/0172; 2017-04-25**  
Technical Assessment Body: **DIBt**  
Notified body/ies: **1343 – MPA Darmstadt**
7. Declared performance/s:  
**Mechanical resistance and stability (BWR 1)**
  - **Characteristic resistance for static and quasi static action, displacements: See appendix, especially Annexes C 1 to C 4****Safety in case of fire (BWR 2)**
  - **Reaction to fire: Anchorages satisfy requirements for Class A 1**
  - **Resistance to fire: NPD**
8. Appropriate Technical Documentation and/or Specific Technical Documentation: ---

The performance of the product identified above is in conformity with the set of declared performance/s. This declaration of performance is issued, in accordance with Regulation (EU) No 305/2011, under the sole responsibility of the manufacturer identified above.

Signed for and on behalf of the manufacturer by:

Andreas Bucher, Dipl.-Ing.

Wolfgang Hengesbach, Dipl.-Ing., Dipl.-Wirtsch.-Ing.

Tumlingen, 2017-05-16

- This DoP has been prepared in different languages. In case there is a dispute on the interpretation the english version shall always prevail.
- The Appendix includes voluntary and complementary information in English language exceeding the (language-neutrally specified) legal requirements.

**Specific Part**

**1 Technical description of the product**

The Upat Drop-in Anchor USA is an anchor made of galvanized or stainless steel which is placed into a drilled hole and anchored by deformation-controlled expansion.

The fixture shall be anchored with a fastening screw or threaded rod.

The product description is given in Annex A.

**2 Specification of the intended use in accordance with the applicable European Assessment Document**

The performances given in Section 3 are only valid if the anchor is used in compliance with the specifications and conditions given in Annex B.

The verifications and assessment methods on which this European Technical Assessment is based lead to the assumption of a working life of the anchor of at least 50 years. The indications given on the working life cannot be interpreted as a guarantee given by the producer, but are to be regarded only as a means for choosing the right products in relation to the expected economically reasonable working life of the works.

**3 Performance of the product and references to the methods used for its assessment**

**3.1 Mechanical resistance and stability (BWR 1)**

Essential characteristic	Performance
Characteristic resistance for static and quasi-static loading, displacements	See Annex C 1 to C 4

**3.2 Safety in case of fire (BWR 2)**

Essential characteristic	Performance
Reaction to fire	Anchorage satisfy requirements for Class A1
Resistance to fire	No performance assessed

**4 Assessment and verification of constancy of performance (AVCP) system applied, with reference to its legal base**

In accordance with European Assessment Documents EAD No. 330232-00-0601 the applicable European legal act is: [96/582/EC].

The system to be applied is: 1

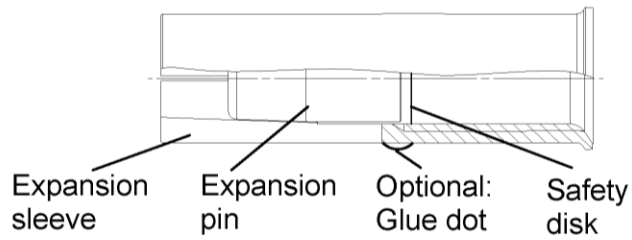
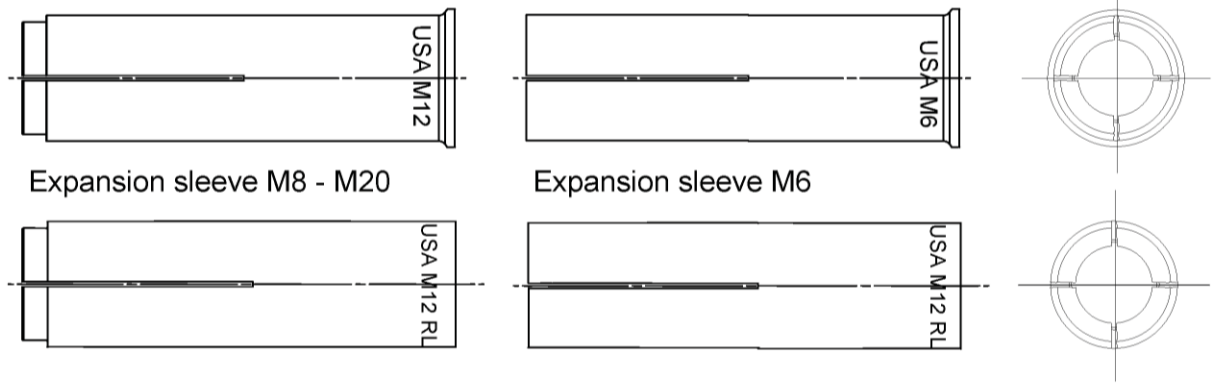

**Intended use in concrete**

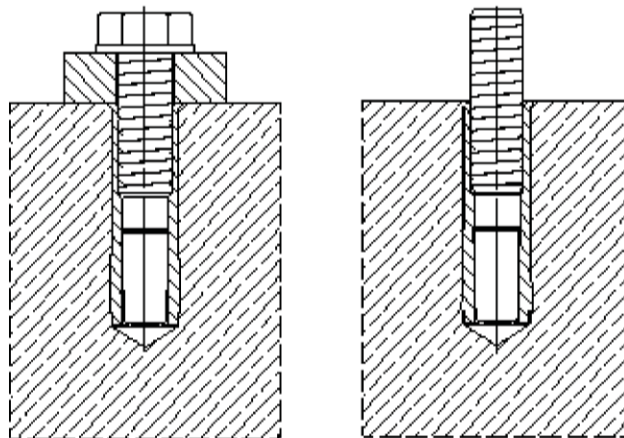

**Upat Drop-in Anchor USA**

**Product description**  
Anchor types  
Installed condition

**Annex A 1**

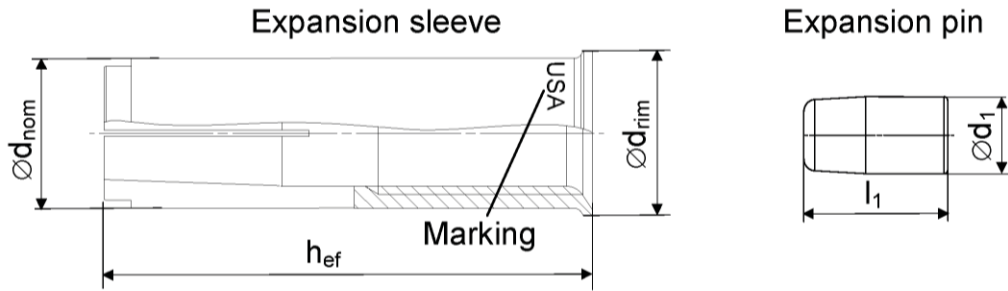

Anchor size USA	M6x30	M8x30	M8x40	M10x30	M10x40	M12x50	M12x50 D	M16x65	M20x80
$h_{ef}$ [mm]	30	30	40	30	40	50	65	80	
$\varnothing d_{nom}$ [mm]	8	10		12		15	16	20	25
$\varnothing d_{rim}$ [mm]	9,5	11,5		13,5		16,5	17,5	21,5	27,0
$\varnothing d_1$ [mm]	5	6,5		8		10		13,5	17,5
$l_1$ [mm]	14	13,5		13	18	18		25	26

**Distinctive feature**

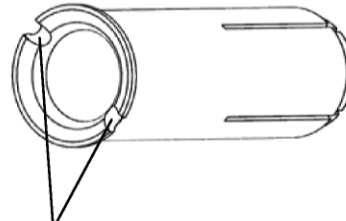
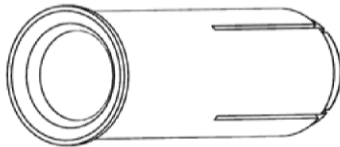

0× groove for:

- USA M6x30..
- USA M8x30..
- USA M10x40..
- USA M12x50..
- USA M16x65..
- USA M20x80..

2× groove for:

- USA M8x40..
- USA M10x30..

**Marking on anchor body**

galvanized steel (gvz)		stainless steel (A4)	
<i>with rim</i>	<i>rimless</i>	<i>with rim</i>	<i>rimless</i>
USA M6x30	USA M6x30 RL	USA M6x30 A4	USA M6x30 RL A4
USA M8x30	USA M8x30 RL	USA M8x30 A4	USA M8x30 RL A4
USA M8x40	USA M8x40 RL	USA M8x40 A4	USA M8x40 RL A4
USA M10x30	USA M10x30 RL	USA M10x30 A4	USA M10x30 RL A4
USA M10x40	USA M10x40 RL	USA M10x40 A4	USA M10x40 RL A4
USA M12x50	USA M12x50 RL	USA M12x50 A4	USA M12x50 RL A4
USA M12x50 D	USA M12x50 RLD	USA M12x50 DA4	USA M12x50 RL DA4
USA M16x65	USA M16x65 RL	USA M16x65 A4	USA M16x65 RL A4
USA M20x80	USA M20x80 RL	USA M20x80 A4	USA M20x80 RL A4

Upat Drop-in Anchor USA

**Product description**  
Anchor types

**Annex A 2**

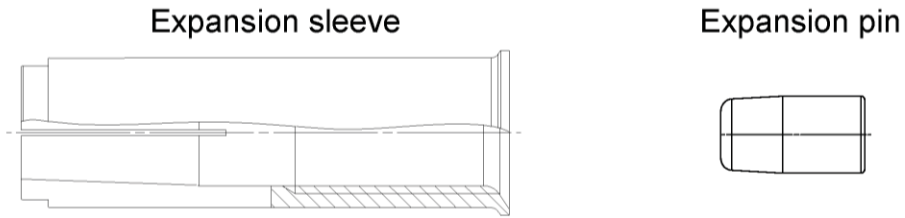

**Table A1: Materials**

Designation	Material	
	galvanised steel ( $\geq 5 \mu\text{m}$ )	stainless steel
Expansion sleeve	EN 10277:2008 or EN 10084:2008 or EN 10111:2008 or EN 10263:2001 or EN 10087:1998 or ASTM A29/A29M	EN 10088:2005
Expansion pin		
Fastening screw or threaded rod	steel, property class 4.6, 5.6, 5.8 or 8.8 according to EN ISO 898-1:2012	property class 50, 70 or 80 according to EN ISO 3506:2009

Upat Drop-in Anchor USA

**Product description**  
Material

**Annex A 3**

**Specifications of Intended use**

**Anchorage subject to:**

- Static and quasi-static loads

**Base materials:**

- Reinforced or unreinforced normal weight concrete according to EN 206-1:2000
- Strength classes C20/25 to C50/60 according to EN 206-1:2000
- Non-cracked concrete: all sizes

**Use conditions (Environmental conditions):**

- Structures subject to dry internal conditions (zinc coated steel or stainless steel)
- Structures subject to external atmospheric exposure (including industrial and marine environment) and to permanently damp internal condition, if no particular aggressive conditions exist (stainless steel)

Note: Particular aggressive conditions are e.g. permanent, alternating immersion in seawater or the splash zone of seawater, chloride atmosphere of indoor swimming pools or atmosphere with extreme chemical pollution (e.g. in desulphurization plants or road tunnels where de-icing materials are used)

**Design:**

- Anchorages are designed under the responsibility of an engineer experienced in anchorages and concrete work
- Verifiable calculation notes and drawings are prepared taking into account the loads to be anchored. The position of the anchor is indicated on the design drawings (e. g. position of the anchor relative to reinforcement or to supports, etc.)
- Design of fastenings in accordance to FprEN 1992-4:2016 and EOTA Technical Report TR 055.
- Fasteners can be used as a single fixing for use in structural application.

**Installation:**

- Anchor installation carried out by appropriately qualified personnel and under the supervision of the person responsible for technical matters of the site
- Create drill hole with hammer drill or with hollow drill and vacuum cleaner
- The anchor may only be used once
- In case of aborted hole: New hole must be drilled at a minimum distance of twice the depth of the aborted hole or closer, if the hole is filled with a high strength mortar and only if the hole is not in the direction of the oblique tensile or shear load
- Anchor expansion by impact using the setting tools given in Annex B 3. The anchor is property set if the stop of the setting tool reaches the expansion sleeve. The manual setting tool with installation control leaves a visible mark on the sleeve, as illustrated in Annex B 3 and B 4

Upat Drop-in Anchor USA	<b>Annex B 1</b>
Intended Use Specifications	

**Table B2: Installation parameters for concrete C20/25 to C50/60**

Anchor size			M6x30	M8x30	M8x40	M10x30	M10x40	M12x50	M12x50 D	M16x65	M20x80
Nominal drill hole diameter	$d_0$	[mm]	8	10		12		15	16	20	25
Effective anchorage depth	$h_{ef}$	[mm]	30	30	40	30	40	50		65	80
Maximum installation torque	max. $T_{inst}$	[Nm]	4	8		15		35		60	120
Minimum drill hole depth	$h_1$	[mm]	32	33	43	33	43	54		70	85
Minimum screw-in depth	$l_{s,min}$	[mm]	6	8		10		12		16	20
Maximum screw-in depth	$l_{s,max}$	[mm]	14	14		14	17	22		28	34
Clearance of hole diameter	$\varnothing d_f \leq$	[mm]	7	9		12		14		18	22
<b><math>h_{min} = 80</math> mm</b>											
Minimum spacing	$s_{min}$	[mm]	70	110	200	200		-	-	-	-
Minimum edge distance	$c_{min}$	[mm]	150	150		150		-	-	-	-
<b><math>h_{min} = 100</math> mm</b>											
Minimum spacing	$s_{min}$	[mm]	65	70	90	150	200		-	-	-
Minimum edge distance	$c_{min}$	[mm]	115	115	160	180	200		-	-	-
<b><math>h_{min} = 120</math> mm</b>											
Minimum spacing	$s_{min}$	[mm]	65	70	85	95	145		-	-	-
Minimum edge distance	$c_{min}$	[mm]	115	115	140	150	200		-	-	-
<b><math>h_{min} = 160</math> mm</b>											
Minimum spacing	$s_{min}$	[mm]	65	70	85	95	145		180	-	-
Minimum edge distance	$c_{min}$	[mm]	115	115	140	150	200		240	-	-
<b><math>h_{min} = 200</math> mm</b>											
Minimum spacing	$s_{min}$	[mm]	65	70	85	95	145		180	190	-
Minimum edge distance	$c_{min}$	[mm]	115	115	140	150	200		240	280	-

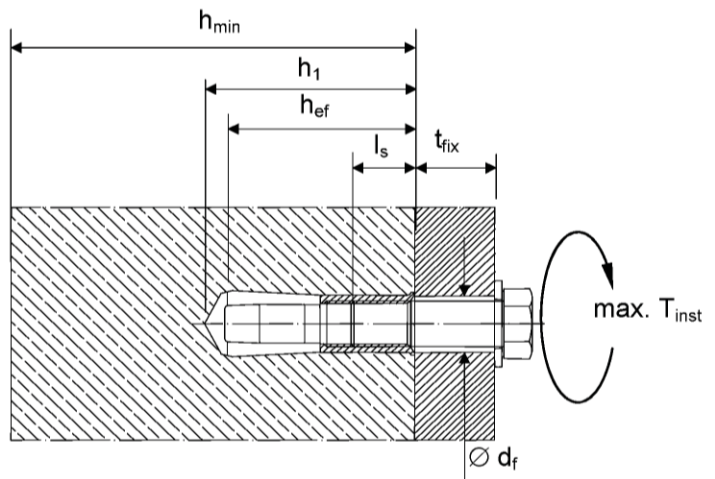
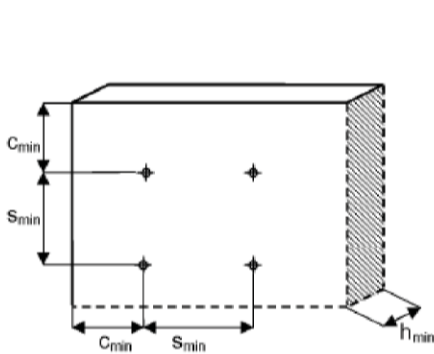

Fastening screw or threaded rod:

- Minimum property class and materials according to table A1
- The length of the fastening screw or threaded rod shall be determined depending on thickness of fixture  $t_{fix}$ , admissible tolerances and maximum screw length  $l_{s,max}$  as well as minimum screw-in depth  $l_{s,min}$

Upat Drop-in Anchor USA

Intended Use  
Installation parameters

**Annex B 2**



Setting & drilling tools

Setting tools

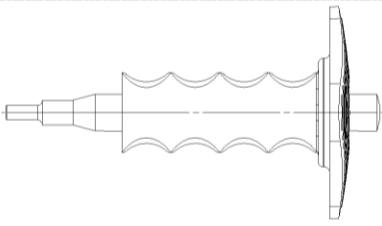
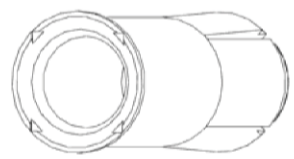
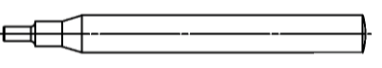
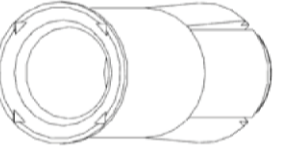
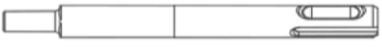
Setting tools	Marking	Description	Marking on USA with rim and rimless
	EHS Plus M..x h <sub>ef</sub>	Manual setting tool with hand guard	
	EHS M..x h <sub>ef</sub>	Manual setting tool basic format	
	EMS M..x h <sub>ef</sub>	Machine setting tool with SDS Plus	No marking

Drilling tools

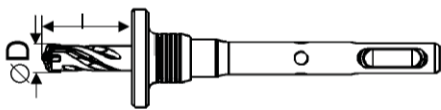

EBB  
∅D x l

Stop drill

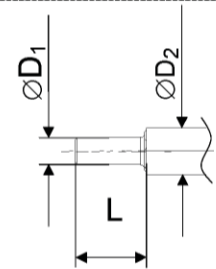

Or other usual drillers

**Table B3: Parameters of setting tools**

Manual setting tool	Machine setting tool	Stop drill	For anchor size USA	∅ D1	∅ D2	L
EHS M6x25/30	EMS M6x25/30	EBB 8x30	USA M6x30	4,8	9,0	17,0
EHS M8x25/30	EMS M8x25/30	EBB 10x30	USA M8x30	6,4	11,0	18,0
EHS M8x40	EMS M8x40	EBB 10x40	USA M8x40			28,0
EHS M10x25/30	EMS M10x25/30	EBB 12x30	USA M10x30	7,9	13,0	18,0
EHS M10x40	EMS M10x40	EBB 12x40	USA M10x40			24,0
EHS M12x50	EMS M12x50	EBB 15x50	USA M12x50	10,2	16,5	30,0
EHS M12x50	EMS M12x50	EBB 16x50	USA M12x50 D			
EHS M16x65	EMS M16x65	EBB 20x65	USA M16x65	13,5	22	36,0
EHS M20x80	EMS M20x80	EBB 25x80	USA M20x80	16,4	27	50,0

Upat Drop-in Anchor USA

**Intended Use**  
Setting & Drilling tools

**Annex B 3**



**Installation instructions**

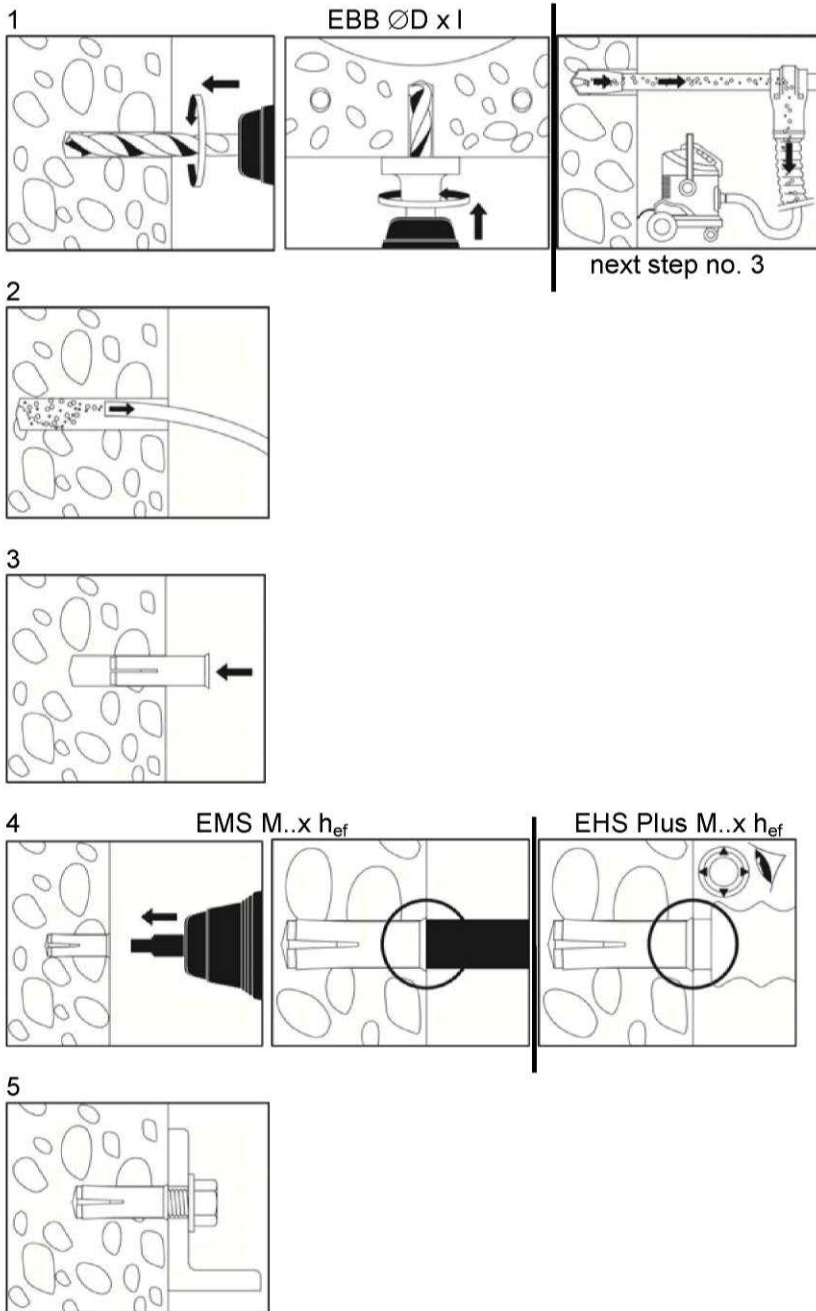

No.	Description
1	Create drill hole with hammer drill or with hollow drill and vacuum cleaner
2	Clean from drill-dust
3	Set anchor till anchor is flush with surface of concrete
4	Expand the sleeve by driving the pin into the sleeve and control the correct setting
5	Fixation of fixture. Maximum installation torque max. $T_{inst}$ must not be crossed

Upat Drop-in Anchor USA

**Intended Use**  
Installation instructions

**Annex B 4**

**Table C1: Characteristic values for tension loads**

USA		property class	M6x30 <sup>1)</sup>	M8x30 <sup>1)</sup>	M8x40	M10x30 <sup>1)</sup>	M10x40	M12x50	M12x50 D	M16x65	M20x80
Inastallation safety factor	$\gamma_{inst}$	[-]	1,0								
<b>Steel failure</b>											
Characteristic resistance	$N_{Rk,s}$ [kN]	A4-50	10,1	18,3		29,0		42,1		78,3	122,4
Partial safety factor	$\gamma_{Ms}$		2,86								
Characteristic resistance	$N_{Rk,s}$ [kN]	A4-70	14,1	19,6		24,9		45,1	59,0	73,8	117,2
Partial safety factor	$\gamma_{Ms}$		1,87			1,5			1,87		1,5
Characteristic resistance	$N_{Rk,s}$ [kN]	A4-80	16,1	19,6		24,9		45,1	59,0	73,8	117,2
Partial safety factor	$\gamma_{Ms}$		1,6			1,5					
Characteristic resistance	$N_{Rk,s}$ [kN]	steel 4.6	8,0	14,6		23,2		33,7		62,7	97,9
Partial safety factor	$\gamma_{Ms}$		2,0								
Characteristic resistance	$N_{Rk,s}$ [kN]	steel 5.6	10,1	18,3		29,0		42,1		78,3	122,4
Partial safety factor	$\gamma_{Ms}$		2,0								
Characteristic resistance	$N_{Rk,s}$ [kN]	steel 5.8	10,1	17,2		21,8		39,6	42,1	64,7	102,8
Partial safety factor	$\gamma_{Ms}$		1,5								
Characteristic resistance	$N_{Rk,s}$ [kN]	steel 8.8	13,5	17,2		21,8		39,6	53,3	64,7	102,8
Partial safety factor	$\gamma_{Ms}$		1,5								
<b>Pull-out failure not decisive</b>											
<b>Concrete cone failure</b>											
Effective anchorage depth	$h_{ef}$	[mm]	30	40	30	40		50		65	80
Characteristic spacing	$s_{cr,N}$	[mm]	90	120	90	120		150		195	240
Characteristic edge distance	$c_{cr,N}$	[mm]	45	60	45	60		75		97	120
Factor $k_1$	$k_{ucr,N}$	[-]	11,0								
<b>Splitting failure</b>											
Characteristic spacing	$s_{cr,sp}$	[mm]	210	280	210	320		350		455	560
Characteristic edge distance	$c_{cr,sp}$	[mm]	105	140	105	160		175		227	280

<sup>1)</sup> Only for application with statically indeterminate structural components.

Upat Drop-in Anchor USA

**Performances**  
Characteristic values for tension loads

**Annex C 1**

**Table C2: Characteristic values for shear loads**

USA		property class	M6x30 <sup>1)</sup>	M8x30 <sup>1)</sup>	M8x40	M10x30 <sup>1)</sup>	M10x40	M12x50	M12x50 D	M16x65	M20x80
Factor for ductility	$k_7$ [-]		1,0								
<b>Steel failure without lever arm</b>											
Characteristic resistance	$V_{Rk,s}$ [kN]	A4-50	5,0	9,2		14,5		21,1		39,2	61,2
Partial safety factor	$\gamma_{Ms}$		2,38								
Characteristic resistance	$V_{Rk,s}$ [kN]	A4-70	7,0	9,8		12,4		22,6	29,5	37	59
Partial safety factor	$\gamma_{Ms}$		1,56		1,25				1,56	1,25	
Characteristic resistance	$V_{Rk,s}$ [kN]	A4-80	8,0	9,8		12,4		22,6	30,4	36,9	58,6
Partial safety factor	$\gamma_{Ms}$		1,33		1,25						
Characteristic resistance	$V_{Rk,s}$ [kN]	steel 4.6	4,0	7,3		11,6		16,9		31	49
Partial safety factor	$\gamma_{Ms}$		1,67								
Characteristic resistance	$V_{Rk,s}$ [kN]	steel 5.6	5,0	9,2		14,5		21,1		39	61
Partial safety factor	$\gamma_{Ms}$		1,67								
Characteristic resistance	$V_{Rk,s}$ [kN]	steel 5.8	5,0	8,6		10,9		19,8	21,1	32	51
Partial safety factor	$\gamma_{Ms}$		1,25								
Characteristic resistance	$V_{Rk,s}$ [kN]	steel 8.8	6,8	8,6		10,9		19,8	27	32	51
Partial safety factor	$\gamma_{Ms}$		1,25								
<b>Steel failure with lever arm</b>											
Characteristic resistance	$M^0_{Rk,s}$ [Nm]	A4-50	8	19		37		66		166	324
Partial safety factor	$\gamma_{Ms}$		2,38								
Characteristic resistance	$M^0_{Rk,s}$ [Nm]	A4-70	11	26		52		92		232	454
Partial safety factor	$\gamma_{Ms}$		1,56								
Characteristic resistance	$M^0_{Rk,s}$ [Nm]	A4-80	12	30		60		105		266	519
Partial safety factor	$\gamma_{Ms}$		1,33								
Characteristic resistance	$M^0_{Rk,s}$ [Nm]	Stahl 4.6	6,1	15		30		52		133	259
Partial safety factor	$\gamma_{Ms}$		1,67								
Characteristic resistance	$M^0_{Rk,s}$ [Nm]	Stahl 5.6	7,6	19		37		66		166	324
Partial safety factor	$\gamma_{Ms}$		1,67								
Characteristic resistance	$M^0_{Rk,s}$ [Nm]	Stahl 5.8	7,6	19		37		66		166	324
Partial safety factor	$\gamma_{Ms}$		1,25								
Characteristic resistance	$M^0_{Rk,s}$ [Nm]	Stahl 8.8	12	30		60		105		266	517
Partial safety factor	$\gamma_{Ms}$		1,25								

<sup>1)</sup> Only for application with statically indeterminate structural components.

Upat Drop-in Anchor USA

**Performances**  
Characteristic values for shear loads

**Annex C 2**

**Table C3: Characteristic values for shear loads**

USA			M6x30	M8x30	M8x40	M10x30	M10x40	M12x50	M12x50 D	M16x65	M20x80
<b>Concrete pry out failure</b>											
Factor	$k_8$	[-]	1,74	1,88	1,74	1,88	2,0				
Installation safety factor	$\gamma_{inst}$	[-]	1,0								
<b>Concrete edge failure</b>											
Effective length of anchor in shear loading	$l_f = h_{ef}$	[mm]	30	40	30	40	50		65	80	
Effective diameter of anchor	$\varnothing d_{nom}$	[mm]	8	10	12		15	16	20	25	

Upat Drop-in Anchor USA

**Performances**  
Characteristic values for shear loads

**Annex C 3**

**Table C4.1: Displacements under tension and shear loads for USA in galvanised steel**

USA				M6x30	M8x30	M8x40	M10x30	M10x40	M12x50	M12x50 D	M16x65	M20x80	
Tension load in C20/25 to C50/60	N	[kN]		4,0		6,1	4,0	6,1		8,5	12,6	17,2	
Displacement	$\delta_{No}$	[mm]		0,1									
	$\delta_{No\infty}$	[mm]		0,2									
Shear load in C20/25 to C50/60	V	[kN]		3,9	4,9		6,2			11,3	15,2	18,5	29,4
Displacement	$\delta_{Vo}$	[mm]		0,95	1,00		1,05		1,10		1,40	1,80	
	$\delta_{Vo\infty}$	[mm]		1,40	1,50		1,60		1,70		2,10	2,70	

**Table C4.2: Displacements under tension and shear loads for USA in stainless steel**

USA A4				M6x30	M8x30	M8x40	M10x30	M10x40	M12x50	M12x50 D	M16x65	M20x80	
Tension load in C20/25 to C50/60	N	[kN]		4,0		6,1	4,0	6,1		8,5	12,6	17,2	
Displacement	$\delta_{No}$	[mm]		0,1									
	$\delta_{No\infty}$	[mm]		0,2									
Shear load in C20/25 to C50/60	V	[kN]		3,2	5,6		7,1			12,9	13,5	21,1	33,5
Displacement	$\delta_{Vo}$	[mm]		0,95	1,00		1,05		1,10		1,40	1,80	
	$\delta_{Vo\infty}$	[mm]		1,40	1,50		1,60		1,70		2,10	2,70	

Upat Drop-in Anchor USA

Performances  
Displacements

Annex C 4